



Support

Have any questions? Feel free to get in touch
<https://creamsource.com/support/>



Table of Contents

1. About the Vortex8

- 1.1 Overview
- 1.2 Part Numbers
- 1.3 Warnings
- 1.4 Compliance Notes

2. Getting started

- 2.1 What's in the Box

3. Water and Temperature

- 3.1 Water
- 3.2 Temperature

4. Transport and Safety

- 4.1 Yoke Assembly
- 4.2 Rigging
- 4.3 Filter Rails
- 4.4 Installing a Dome
- 4.5 Installing a Honeycomb
- 4.6 Installing a Diffuser

5. Controls

- 5.1 Controlling the Vortex8
- 5.2 On-board Keypad and Display
- 5.3 Introducing CreamOS
- 5.4 CreamOS Home Screen
- 5.5 CreamOS Colour Mode
- 5.6 CreamOS Effects Mode
 - 5.6.1 Effects Off
 - 5.6.2 Candle & Fire
 - 5.6.3 Emergency
 - 5.6.4 Television
 - 5.6.5 Party
 - 5.6.6 Pulse
 - 5.6.7 Paparazzi
 - 5.6.8 Colour Cycle
 - 5.6.9 Strobe
 - 5.6.10 Random
 - 5.6.11 Dual Level
 - 5.6.12 Sync Flash
 - 5.6.13 Flash Frames
 - 5.6.14 Calibrate Sync
- 5.21 Notifications Tray / Status Bar
- 5.22 User Presets
- 5.23 Storing a User Preset
- 5.24 Restoring a User Preset
- 5.25 Clearing a User Presets
- 5.26 Clear All User Presets
- 5.27 Menu Functions

6. Connectivity

- 6.1 Best Of Class Connectivity
- 6.2 Wired DMX Control
- 6.3 Wireless DMX Control
- 6.4 Streaming ACN (sACN)
- 6.5 Wired Remote Dimmer
- 6.6 Link Multiple Vortex8 Fixtures
- 6.7 Firmware Updates Via USB

7. Camera Sync

- 7.1 Syncing to Cameras
- 7.2 Setting up Camera Syncing with Sync/
Genlock Input using the Flashbandit
- 7.3 Setting up Camera Syncing with Sync/
Genlock Output using the Accessory BNC Cable
- 7.4 Syncing Multiple Units
- 7.5 Calibrate Sync
- 7.6 Shooting While Calibrated
- 7.7 External Effects Triggering

8. Maintenance

- 8.1 Vortex8 Fuse

9. Power

- 9.1 Running from Batteries
- 9.2 Setting a Power Limit
- 9.3 Pinout for DC Power connector on Vortex8

10. Specifications

- 10.1 Specs for the Accessory Port Pinout
- 10.2 Specs for the Vortex8
- 10.3 Warranty
- 10.4 Support

1. About the Vortex8

1.1 Overview

The Vortex8 is a versatile 2x1 RGBW system with a CCT range from 2200K to 15000K that can be used as a hard punch light to bounce or push through diffusion, or as a creamy soft light with the Creamsource Dome or DoPchoice Snapbag. Effects and colour gels are built into the latest CreamOS architecture in addition to a range of new features wrapped into an intuitive user interface. Unpredictable weather and messy effects machines are no longer a worry for the lighting department where the Vortex is in place. The Vortex8 is IP65 water resistant and sealed for the ultimate security and efficiency. Rain, snow and dust wont hold the Vortex8 back.

Connectivity to the Vortex8 is well up to date with LumenRadio TimoTwo built in, Ethernet, Bluetooth, 5pin DMX, Wifi, USB type A and Creamsource Accessory port. Interaction between Vortex8 and various third party instruments and protocols are endless opening various wired and wireless control options. We are geeks for high quality and precision engineering, and loads of our geekiness has spilled into the Vortex Series. Built with elegance and durability in mind the aluminium machining and technopolymer infusion has allowed us to achieve our goals. Containment and simplicity is also achieved in this design, with the PSU as well as the antennas integrated into the head.

We stand by our users offering 5 years Warranty when you register your product. Go to www.creamsource.com for more information.



Vortex8 in action

1. About the Vortex8















1.2 Part Numbers

The table below lists part numbers for the Creamsource Vortex system.

Part Number	Description
K-CSV-8-ESS	Vortex8 Essentials Kit: Includes Fixture, Yoke, Power Cable, Flat Diffuser.
CSV-8	Vortex8 650W Colour Fixture, Head Only

1. About the Vortex8

1.3 Warnings

-  **IMPORTANT** - Power Vortex8 with the supplied PowerCon Cable only. (When using Vortex8 with water you must only use the supplied cable as not all PowerCon cables are water resistant.)
-  Use etherCON TOP connector only for preventing water from damaging ethernet ports
-  Vortex8 is rated IP65. Vortex8 must NOT be submerged in water.
-  Heavy -Vortex8 weighs 13.7kg/30lbs. Lift with care.
-  Not intended for permanent outdoor use. Temporary outdoor use only.
-  Do not open or disassemble the fixture under any circumstances, doing so voids warranty and may cause harm to you if powered.
-  Do not stare directly at the light beam.
-  Ensure that the Vortex8 is clear of any obstructions in any direction with a minimum distance of 45cm/18".
-  This product is intended for professional use and may only be operated by qualified persons.
-  Do not cover the ventilation slots on the side and rear of the Vortex8. Airflow is required for cooling and operation.
-  Inspect the power cable for damage prior to operation.
-  Check for visible damage to the fixture, cables or connectors and do not operate the device if damaged. Please contact your nearest authorised repair centre for the fixture to be repaired.
-  Always ensure that the fixture is earthed electrically.
-  The fixture may become hot during operation. Maximum Surface Temperature $T_c = 70^{\circ}\text{C}$.

1. About the Vortex8

1.4 Compliance Notes

This device complies with Part 15 of the FCC Rules. Operation is subject to the following two conditions: **(1)** This device may not cause harmful interference, and **(2)** This device must accept any interference received, including interference that may cause undesired operation.

Certifications: CE, FCC, RCM



Please make sure discarded electrical waste is properly recycled to reduce environmental impact. Please use a separate collection facility or contact the supplier from which this fixture was purchased.

2. Getting started

2.1 What's in the Box

Vortex8 ships with the following items included in the box.

- 1 *Vortex8*
- 2 *Yoke*
- 3 *AC PowerCON Cable*
- 4 *T30 Torx Key*



3. Water and Temperature

3.1 Water

The IP65 rating of the Vortex8 fixture means it can survive low pressure water jets in all directions, but **not full submersion**. It also means that it has a high resistance to dust and dirt. Precautions are advised.

 *The supplied PowerCon cable must be used when the Vortex8 is exposed to water. Not all PowerCon cables are water resistant and can be an electrical hazard.*



3.2 Temperature

The Vortex8 is a high powered lighting fixture and will get quite hot during operation, especially on the aluminium chassis due to heat dissipation. Care must be taken when handling the Vortex8.

- The maximum surface temperature of the lamp head will be 60° C/140°F, when operated in an ambient temperature of 25° C/77° F
- Maximum ambient temperature for normal operation is 40°C/104°F.

4. Transport and Safety

4.1 Yoke Assembly

The Vortex8 ships with a quick release yoke system that is assembled using a T30 Torx tool provided.

The standard yoke allows for mounting to a combo stand with a standard baby pin receiver.



1 *Included parts.*



2 *Use the hex key to fix yoke arms to base.*



3 *Adjust until finger tight, do not over tighten.*



4 *Repeat on the other side.*

4. Transport and Safety

4.2 Rigging

The Vortex8 has a unique dual 3/8th threaded corner system to support complex rigging setups and Vortex8 arrays .

 *Ensure that mounting point is safe and secure and is rated to take the full unit weight.
Ensure fastener length does not exceed the depth of the threaded rigging point, or they may become stuck.*

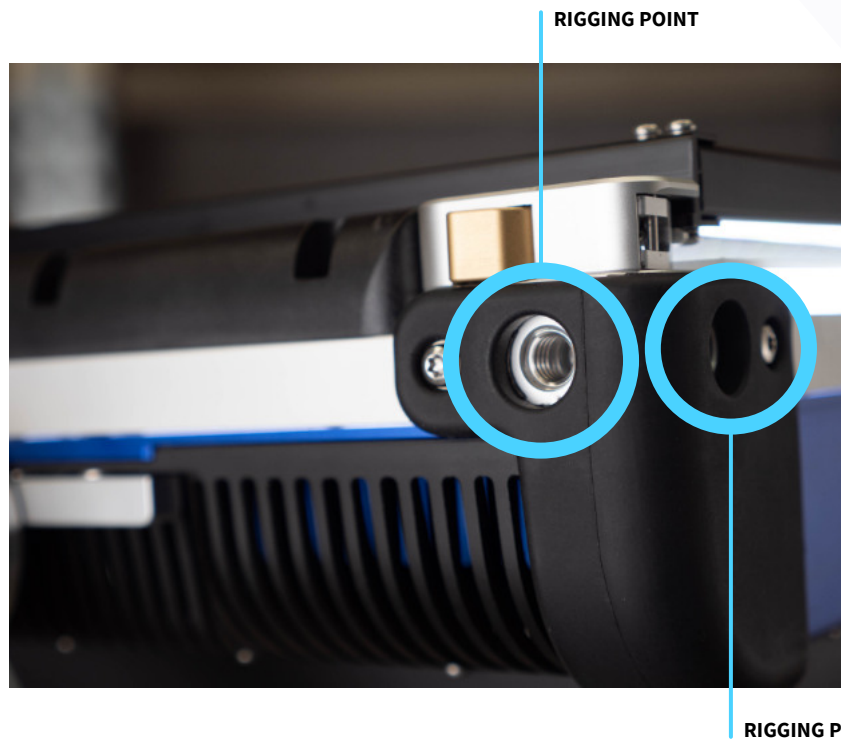

4. Transport and Safety

4.3 Filter Rails

There are various accessories that are available for V8 that can slide into the front two accessory rails. Eg a standard diffuser and a honeycomb grid. Accessories slide into the rail system and lock securely with unique lock and latch system.



The filter rail slot has a unique locking mechanism that locks the initial filter in while allowing second filter to be inserted without unlocking.



Latch in unlock position.



Push top latch down to engage the lock.



Push gold button to release to unlock.

4. Transport and Safety

4.4 Installing a Dome

Installing the Dome the Vortex8 widens the native 20° beam angle. This modifier softens the source and reduces shadowing.

Install the Dome into the safety filter rail as per steps above in the “Rails Filter” section.



Slide the dome into the first filter rail.



Push top latch down to engage the lock on each side.

4. Transport and Safety

4.5 Installing a Honeycomb

The honeycomb reduces the beam angle and stops ambient spill of light. This works great in with the standard diffuser in the second slot.



Slide the honeycomb into the first filter rail.



Push top latch down to engage the lock on each side.

4. Transport and Safety

4.6 Installing a Diffuser

The standard diffuser softens the native hard light and widens the beam angle. This modifier works well in conjunction with the dome and the honeycomb.



Slide the diffuser into the first filter rail.



Push top latch down to engage the lock on each side.

5. Controls

5.1 Controlling the Vortex8

There are several different ways of controlling the fixture, which are detailed below.

- 1

On-board keypad and display
- 2

Wired DMX
- 3

Wireless DMX using inbuilt Lumen Radio system
- 4

Wired remote dimmer control *(sold separately)*
- 5

sACN over ethernet connection

5.2 On-board Keypad and Display

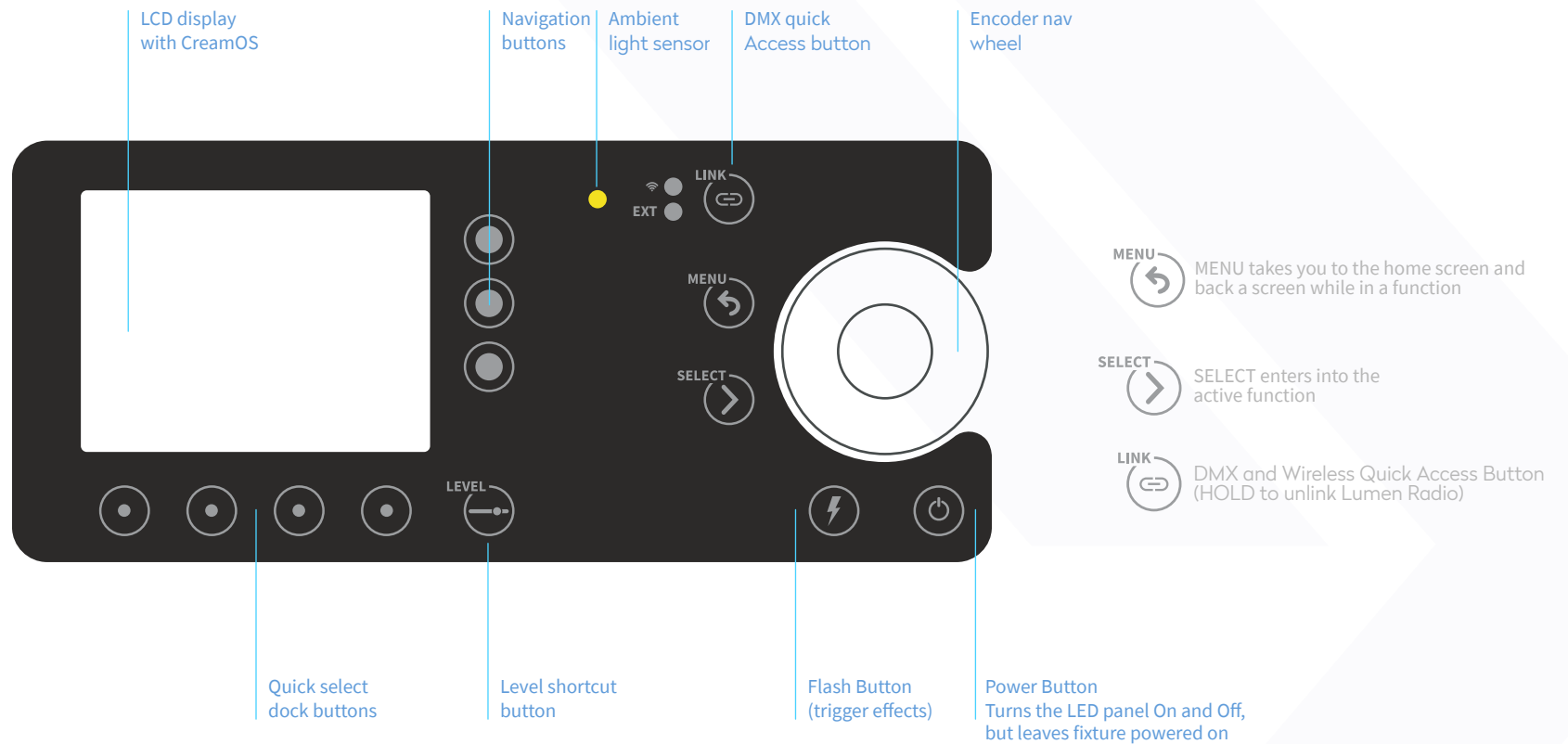

5. Controls

5.3 Introducing CreamOS

CreamOS is the all new operating system based on architecture that is robust and expandable. CreamOS continues to evolve with easy access and a user friendly interface.

CreamOS is driven by the following screens:



Colour Mode

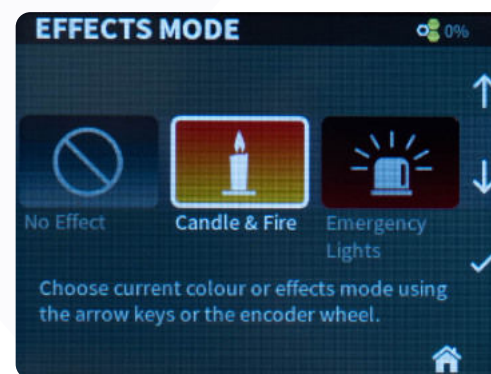

Effects Mode



Home screen

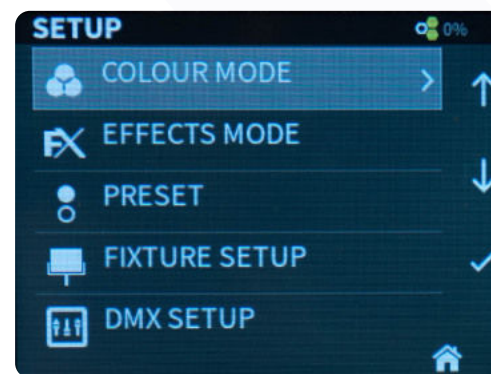

Settings screen

Visit www.creamsource.com/support for the latest version of CreamOS.

5. Controls

5.4 CreamOS Home Screen

Control parameters and access the functions from the home screen.



The screenshot shows the CreamOS Home Screen with the following elements and functions:

- Current mode:** Displayed as 'RGBW' at the top left.
- Notifications tray:** Located at the top right, showing a battery icon and '0%'.
- Colour mode:** Controls for RED (99%), GREEN (100%), BLUE (52%), and WHITE (52%) with corresponding progress bars.
- Effects mode:** Represented by an 'FX' icon. When orange, it indicates 'Effects Mode is on'. A note says 'Hold to turn off an Effect'.
- User Presets / Next Page:** Represented by a person icon and a right-pointing arrow. A note says 'Hold to access User Preset when Next Page is shown'.
- Level:** A horizontal bar at the bottom showing a selected parameter tile (highlighted in orange) and a value of '12%'.
- Quick select parameter dock:** A dock at the bottom with buttons for RED, GREEN, BLUE, and WHITE.

5. Controls

5.5 CreamOS Colour Mode

Easily switch Colour modes from this screen.



The screenshot shows the 'COLOUR MODE' menu with the following callouts:

- Notifications tray**: Points to the top right corner of the menu.
- Cycle forward**: Points to the left arrow button.
- Cycle back**: Points to the right arrow button.
- Select mode**: Points to the checkmark icon.
- Colour mode description**: Points to the text at the bottom of the menu.
- Selected colour mode**: Points to the HSI mode icon, which is highlighted with a white border.

To the right of the menu is a grid of nine icons representing different colour modes:

- CCT**: Icon of a projector.
- HSV**: Icon of a color wheel.
- RGBW**: Icon of three horizontal sliders.
- XY**: Icon of a color triangle.
- GELS**: Icon of a 3x3 grid of colored squares.
- CCT HSV**: Icon of a color wheel with a projector symbol.
- CCT RGBW**: Icon of three horizontal sliders with a projector symbol.
- CCT XY**: Icon of a color triangle with a projector symbol.
- CCT GELS**: Icon of a 3x3 grid of colored squares with a projector symbol.

For more information about the Colour Mode menu, go to **5.7 Menu Functions**

5. Controls

5.6 CreamOS Effects Mode

Enter the Effects  menu and select one of the following presets. Each preset has multiple parameters that can be changed to customise the effects.

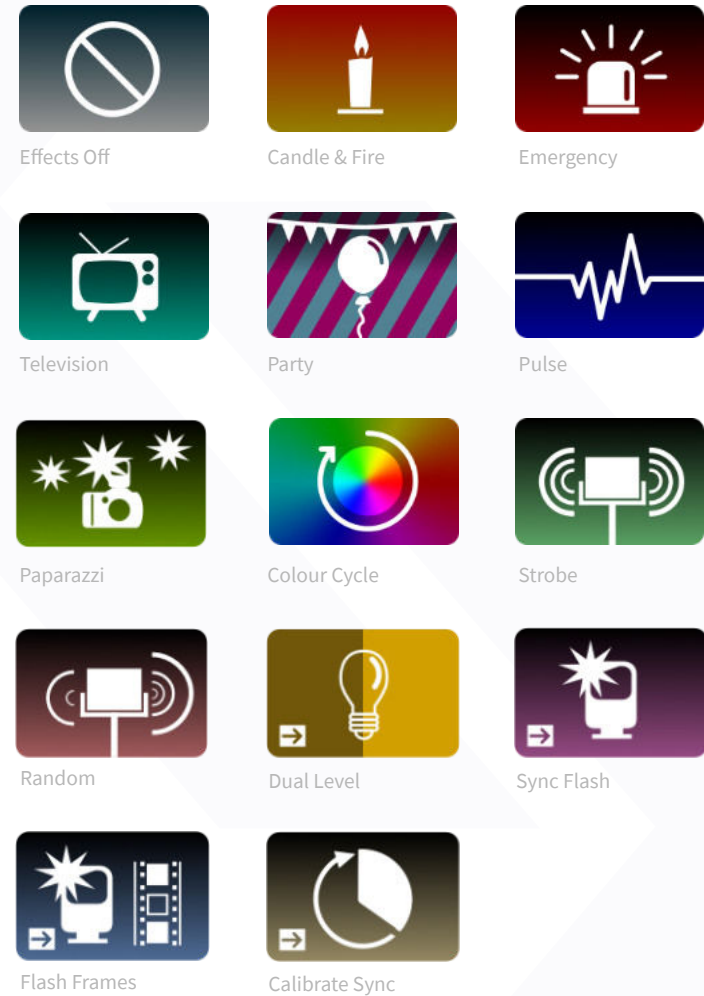

 This icon is displayed on effects that require an external sync source.

More effects may be added in future firmware updates. Visit www.creamsource.com/support for the latest version of CreamOS.

5. Controls

5.6.1 Effects Off

This is the default setting and will turn off any effects.



5.6.2 Candle & Fire

Realistic candle and firelight effects with control over preset, intensity, speed and colour.



SETTING	RANGE	DESCRIPTION
PRESET	1-8	Choose from presets that closely mimic various fire effects. 1 Custom / 2 Calm Candle / 3 Windy Candle / 4 Fireplace / 5 Campfire / 6 Bonfire / 7 Inferno / 8 Gas Fire
INTENSITY	0-100%	Intensity of effect (amount brightness can vary by)
SPEED	0-100%	Speed that the effect will flicker
COLOUR	1400-5600k / Custom	The colour temperature of the effect. If set to Custom, can use any colour set in Colour Mode screen.

5.6.3 Emergency

Emergency lights such as police and ambulance with control over preset, colour, flashes, speed and pause time.



SETTING	RANGE	DESCRIPTION
PRESET	1-14	Choose from presets that will save time for setting up. If set to Custom, can use any colour set in Colour Mode screen.
COLOUR	1-13	Preset colours used for the effect
FLASHES	1-20	Number of flashes of each colour
SPEED	0-100%	Speed of the effect
PAUSE TIME	0-2000ms	Pause duration between each flash

5. Controls

5.6.4 Television

Changes CCT and green/magenta to simulate light cast by TV screen, with control over speed, dynamic range and CCT.



SETTING	RANGE	DESCRIPTION
SPEED	0-100%	Speed of effect
DYNAMIC RANGE	0-100%	Dynamic range of effect (amount brightness can vary by)
CCT	2200-10000k	Base CCT for the effect

5.6.5 Party

Dynamic colour changing party lights with control over palette, speed, transition type and transition speed.



SETTING	RANGE	DESCRIPTION
PALETTE	1-9	Choose colour palette from the following PRIMARY 6 / PRIMARY 12 / PRIMARY 24 / WARM / COOL / WARM & COOL / PASTEL / PURPLE RAIN / ULTRAVIOLET
SPEED	0-100%	Speed of the effect
TRANSITION	1-3	Change the way the effect will transition between colours
TRANSITION SPEED	0-100%	Speed of the transition

5. Controls

5.6.6 Pulse

Pulse of light fading in and out with control of frequency and pulse speed.



SETTING	RANGE	DESCRIPTION
FREQUENCY	0-100%	How often the effect will display
PULSE SPEED	0-100%	The speed the pulse effect

5.6.7 Paparazzi

Random camera flash-bulb effect with control of speed, decay speed and CCT.



SETTING	RANGE	DESCRIPTION
SPEED	0-100%	Speed of the effect (interval between flashes)
DECAY SPEED	0-100%	How quickly the flash fades
CCT	1700-15000k / Custom	Base CCT for the effect

5.6.8 Colour Cycle

Cycle through the spectrum of saturated colours with control over speed.



SETTING	RANGE	DESCRIPTION
SPEED	0-100%	The speed the colour cycling

5. Controls

5.6.9 Strobe

Strobe effect with control over frequency, brightness & duty cycle.



SETTING	RANGE	DESCRIPTION
FREQUENCY	0.1-50Hz	Frequency of strobe effect
DUTY CYCLE	0-100%	The ratio between light OFF and ON times

5.6.10 Random

Create a random pattern of flashes with control over frequency, length & variation.



SETTING	RANGE	DESCRIPTION
FREQUENCY	0.05-5.0Hz	Frequency of random effect
LENGTH	2-200ms	Maximum length of any flash
VARIATION	0-100%	The amount of variation allowed from the effect

5.6.11 Dual Level

Set two different light levels and instantly switch between them using Flash button, DMX or external trigger signal.



SETTING	RANGE	DESCRIPTION
FLASH LEVEL	0-100%	Light output when FLASH button pressed on the control panel

5. Controls

5.6.12 Sync Flash

Used to create flashes of a defined duration, similar to a Studio Strobe light. A modelling level can also be set. The flash can be triggered by pressing the Flash button, DMX or by an external trigger signal such as a camera hot shoe.



SETTING	RANGE	DESCRIPTION
FLASH LEVEL	0-100%	Light output when FLASH triggered
FLASH TIME	1/5000 th - 1/5 th sec	Duration the light is flashed ON for

5.6.13 Flash Frames

Use this mode to create flashes tightly synchronised to the camera shutter. Must be used in conjunction with a sync source such as Creamsource FlashBandit, or Genlock output of camera.

The duration of the flash ON and OFF is specified in Frames - e.g. Flash 1 frame ON, followed by 3 frames OFF, repeat. The Frame Offset is useful if using this effect with multiple fixtures, so they can respond to different frames.



SETTING	RANGE	DESCRIPTION
OFF LEVEL	0-100%	Brightness for the OFF frames
FRAMES ON	1-255	No. of frames to flash ON
FRAMES OFF	1-255	No. of frames to flash OFF
OFFSET	0-255	No. of frames to offset the sequence by, from first frame received



To ensure the frame sequence is correctly synchronised when using multiple units, you should reconnect camera sync to the Master unit after changing the Frames Off, Frames On or Offset values.

5. Controls

5.6.14 Calibrate Sync

This is a special mode used for calibrating the light to an external sync source, such as the FlashBandit sync box. It is used to make sure the camera shutter and Vortex8 are synchronised, to prevent the flash-banding effects when shooting on a CMOS sensor camera or when using frame synchronised effects such as Flash Frames.



SETTING	RANGE	DESCRIPTION
SYNC PHASE	0-360	Change the phase offset of the camera sync input. Adjust until the flashing light cannot be seen in the camera monitor.



*Ensure that you setup a camera sync signal that is connected to the Accessory port. See **7. Camera Sync** for a more detailed process of this setup.*

5. Controls

5.21 Notifications Tray / Status Bar

The notification tray in the top right corner will display active features or warnings.

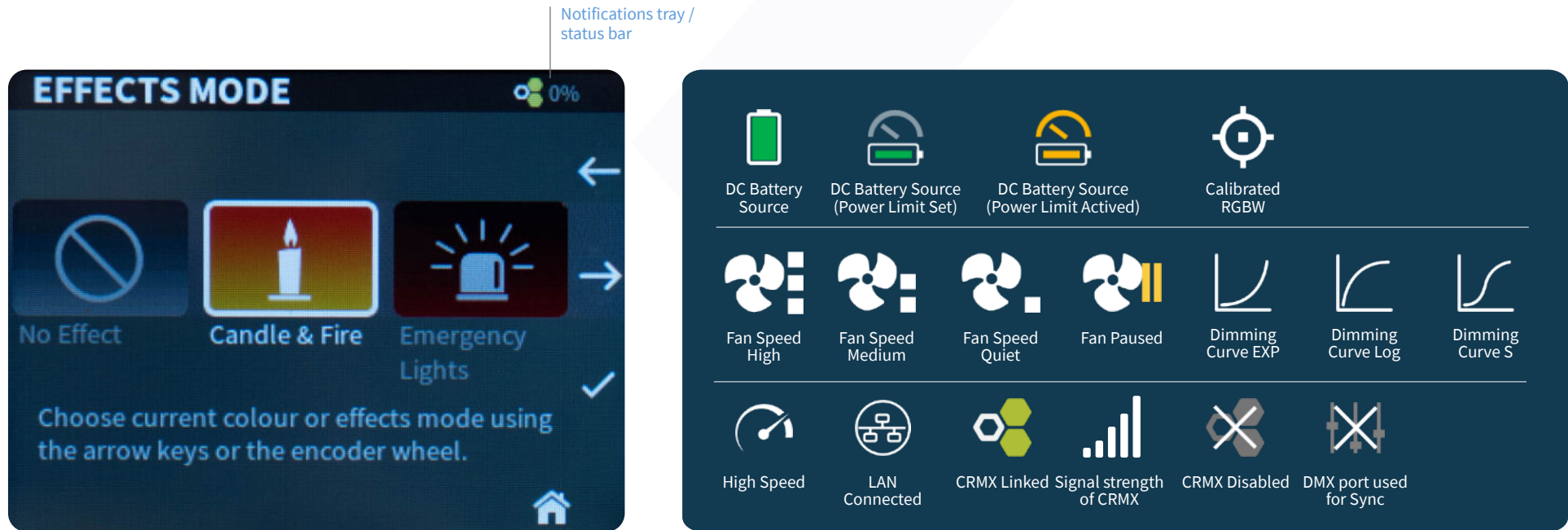

5. Controls

5.22 User Presets

The User Preset menu can be accessed from the Home screen shortcut icon or the Settings menu, from here you will be able to store, restore and clear User Presets for Effects and Colour modes.



TIP When creating a User Preset for a Colour mode, if an Effect is running, the User Preset will store both the Effect and Colour parameters. The icon in the User Preset list will display the Effect and not Colour mode icon.

5. Controls

5.23 Storing a User Preset

1. Select an Effect or Colour and adjust the parameters to the desired result.
2. Select the User Preset from the Home screen or Settings menu.
3. Choose an empty slot and press Select to store it to that slot. A dialogue message will appear to show it has been stored.

5.24 Restoring a User Preset

1. Go to the User Preset menu.
2. Scroll to a slot with the stored User Preset.
3. Press Select to restore that User Preset. A dialogue will inform you that it has been successfully restored.

5.25 Clearing a User Presets

1. Go to the User Preset menu.
2. Scroll to a slot with the stored User Preset.
3. Press and hold down Select button. A dialogue will show to confirm your choice.

5.26 Clear All User Presets

1. Go to the User Preset Options menu.
2. Select Clear All Preset.
3. Select this and a dialogue will show to confirm your choice.

5. Controls

5.27 Menu Functions

The table below outlines all the menu items and a brief description of their function, for firmware **V1.2.0** and above.

COLOUR MODE	→	CCT	→	White light with variable colour temperature and green/magenta control
		HSI	→	Vivid colours with Hue and Saturation control
		RGBW	→	Direct control of Red, Green, Blue and White channels
		XY	→	Calibrated colour control using X,Y coordinates
		GEL	→	Select from over 300 industry standard lighting gels
		CCT-HSI	→	Crossfade between CCT and HSI modes
		CCT-RGBW	→	Crossfade between CCT and RGBW modes
		CCT-XY	→	Crossfade between CCT and XY modes
		CCT-GEL	→	Crossfade between CCT and GEL modes
EFFECTS MODE	→	No Effect	→	All effects disabled
		Candle & Fire	→	Realistic candle and firelight effect with control over preset, intensity, speed and colour
		Emergency Lights	→	Emergency lights such as police and ambulance with control over preset, colour, flashes, speed and pause time
		Television	→	Changes CCT and green/magenta to simulate light cast by TV screen, with control over speed, dynamic range and CCT
		Party	→	Dynamic colour changing party lights with control over palette, speed, transition type and transition speed
		Pulse	→	Pulse of light fading in and out with control of frequency and pulse speed
		Paparazzi	→	Random camera flash-bulb effect with control of speed, decay speed and CCT
		Colour Cycle	→	Cycle through the spectrum of saturated colours with control over speed
		Strobe	→	Strobe effect with control over frequency, brightness & duty cycle
		Random	→	Create a random pattern of flashes with control over frequency, length & variation
		Dual Level	→	Set two different light levels and instantly switch between them using Flash button, DMX or external trigger signal
		Sync Flash	→	Used to create flashes of a defined duration, similar to a Studio Strobe light. A modelling level can also be set.
		Flash Frames	→	Use this mode to create flashes tightly synchronised to the camera shutter. Must be used in conjunction with a sync source such as Creamsource FlashBandit
		Calibrate Sync	→	Helps synchronise the camera shutter and Vortex8 to prevent the flash-banding effects when shooting on a CMOS sensor camera

5. Controls

5.27 Menu Functions Cont.

USER PRESET		Store, restore and clear User Presets for Effects and Colour modes	
	→	User Preset Options	→ Restore Preset Level - When enabled the brightness level of the preset will also be restored
			→ Clear All User Presets - Delete all User Presets
PRESET	→	Select from a range of CCT and Colour presets for recall of commonly used colours	
FIXTURE SETTINGS	→	FAN MODE	→ Auto - Variable speed fan control based on temperature of fixture
			→ Quiet - Fans run at constant low speed
			→ Medium - Fans run at constant medium speed
			→ High - Fans run at constant high speed
			→ Pause - Fans are stopped temporarily until until fixture heats up (should not be used for long periods of time)
	→	DIMMING CURVE	→ Linear - Linear dimming curve
			→ Exponential - Smoothest dimming at low levels
			→ Logarithmic - Smoothest dimming at high levels
			→ S Curve - Smoothest dimming at low and high levels
	→	Calibrated RGBW	→ Activate calibrated colour space for RGBW modes. This uses the Kodak Pro Photo Colour Gamut / Plasa standard E1.54. The white point is set to 3200K
	→	High Speed	→ Enables High Speed mode for shooting at high frame rates. Disable for best colour accuracy and dimming performance
	→	Blackout On Startup	→ Select to force the fixture to power on with the fixture output turned off. When DMX is received, the fixture will turn on. If not selected, then fixture will power on with the last used output level
		Battery Power Limit	→ Set power limit (in Watts) when running on battery power. Set to maximum to disable power limiting.
DMX SETTINGS	→	DMX Address	→ Set DMX Address from 1 to 508
		DMX Mode	→ Choose active DMX Mode
		DMX Smoothing	→ Off - No smoothing is applied to DMX data, fastest response time
			→ Smooth - Interpolation over two DMX frames for smooth dimming, reduced response time
			→ Super Smooth - Interpolation over five DMX frames for super smooth dimming, slow response time
		DMX Forwarding	→ When enabled fixture will forward incoming sACN or CRMX DMX packets out of the DMX port.
LINK	→	CRMX Settings	→ CRMX Unlink - Unlink LumenRadio from all transmitters (shortcut - hold LINK button for two seconds)
			→ CRMX Enabled - Enable or disable LumenRadio receiver
			→ CRMX BLE Enabled - Enable to allow bluetooth devices to communicate with LumenRadio TimoTwo
			→ CRMX BLE Disabled - Disable to prevent bluetooth devices from communicating with LumenRadio TimoTwo
		DMX Settings	→ Shortcut to DMX Settings Menu (see DMX SETTINGS above for a detailed description)

5. Controls

5.27 Menu Functions Cont.

LINK	→	sACN & Network	→	Network Summary - Displays all network addresses and settings on one screen
			→	sACN Enabled - Turns on the streaming ACN protocols
			→	sACN Universe - Select sACN Universe to receive
			→	DHCP Enabled - Automatically assigns the IP address of the fixture
			→	Static IP Addr - Shows the assigned static IP. By default this is 192.168.1.99
			→	Subnet Mask - Shows the current subnet mask address. Default value is 255.255.255.0
			→	Default Gateway - Displays the default gateway for the fixture which is 192.168.1.1
			→	Restore Defaults - Reverts all network settings to their default values
				Master Mode
ADVANCED	→	Sync Options	→	Send Sync via DMX - Sync signal will be sent over the DMX port. Note that normal DMX data is disabled when this is enabled and a status icon will be visible in status bar
			→	Receive Sync via DMX - The fixture will receive sync signal via DMX port if this is enabled. Note that normal DMX data is disabled when this is enabled and a status icon will be visible in status bar
			→	Camera Sync Phase - Setup the camera sync phase
			→	Invert Input Level - Select this to invert input level on the Sync pin (logic HIGH input becomes logic LOW and visa-versa)
		Demo Multi-Zone	→	When enabled, the fixture will automatically start the multi-zone sequence. Show all your friends.
		Information	→	Show system information such as Serial Number, IP Address, Hardware type
Restore All Defaults	→	Restore all fixture settings to the factory defaults. Note: <i>User Presets will not be cleared.</i>		

6. Connectivity

6.1 Best Of Class Connectivity

Vortex8 is equipped with a wide range of connectivity options both wireless and wired.

Order of priority for DMX communications: Wired DMX → sACN → CRMX → ACC



6. Connectivity

6.2 Wired DMX Control

Standard 5 pin XLR connectors are located on the back of the unit. The connectors are Neutrik TOP series, and will only be water resistant when mated with other Neutrik TOP connectors.

When valid DMX signal is present, the yellow EXT indicator on the keypad will light up and the DMX home screen is displayed, which shows active DMX parameters and quick keys to change DMX Address, Mode and Smoothing options. Local control of the fixture is overridden when DMX control is active.

DMX Address and Mode can be selected from the DMX SETUP Menu. Please see the DMX Implementation Tables for more information about the channel mapping options.

6.3 Wireless DMX Control

Every Vortex unit has built in Wireless DMX control using the LumenRadio CRMX system.

When a valid wireless DMX signal is present, the blue Wireless indicator on the keypad will light up. The current signal level will also be displayed on the top status area of the OLED screen

If wired DMX is connected at the same time as the Wireless DMX is receiving data, then the wired connection will take control.

The DMX Address and Mode should be set in the same manner as for wired DMX.

To unlink the LumenRadio CRMX module, press the LINK button and select CRMX Settings > Unlink CRMX (or hold down the LINK button for 2 seconds).

Please see *Lumen Radio documentation* for more information about the wireless DMX system.



If the 'DMX Forwarding' option is enabled in the DMX menu, then incoming CRMX DMX data will be forwarded to the DMX port. It is recommended to keep 'DMX Forwarding' disabled if you plan to hot-swap between CRMX / sACN and DMX data.

6. Connectivity

6.4 Streaming ACN (sACN)

sACN DMX data can be received via the Ethernet port, on universe 1 to 63,999. The device uses Multicast sACN implementation as per the ANSI E1.31 standard. The IP address of the fixture can be configured either as Static, or via DHCP.

The DMX Address and Mode should be set in the same manner as for wired DMX.

When valid sACN signal is present, the yellow EXT indicator on the keypad will light up and the DMX home screen is displayed.

The ethernet connector is a Neutrik etherCON TOP type, and will be only be water resistant when mated with other Neutrik etherCON TOP connectors.



If the 'DMX Forwarding' option is enabled in the DMX menu, then incoming sACN DMX data will be forwarded to the DMX port. Note it may not be possible to hot-swap to Wired DMX with this option enabled (due to data clash between the DMX Output and DMX Input).

6.5 Wired Remote Dimmer

The wired remote dimmer plugs into the 7 pin Accessory connector on the back of the unit. This will allow basic control of the fixture including Brightness, Level, CCT, Tint, Hue and Saturation.

6.6 Link Multiple Vortex8 Fixtures

Enable Master mode under the Link Menu. Multiple Creamsource fixtures can be connected together to operate in unison, without an external DMX controller. Use DMX cable to connect the units. Note that configuration and settings are not transmitted between units, only brightness and colour settings.



More than one unit can be set to Master Mode at a time. Any change to brightness or colour settings on a unit set to Master Mode will be transmitted to the other units.

If using one of the built in effects, make sure only the Master unit is set to the effect mode, and the others are set to 'No Effect'.

6. Connectivity

6.6 Link Multiple Vortex8 Fixtures Cont.

Linking to other fixture is a simple process.



Master Fixture



Replica Fixture

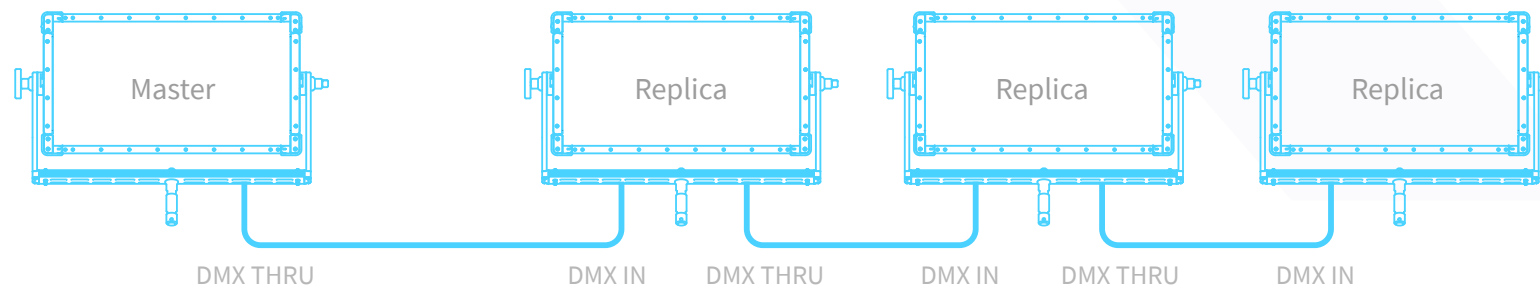

6. Connectivity

6.7 Firmware Updates Via USB

Download the latest CreamOS update from www.creamsource.com/support.

1. Copy the file to a USB drive.

*Note: Only one *.sfb update file should be copied onto the drive at a time.*

2. Insert USB drive into USB connector on Vortex.

3. Power up Vortex8 and it will automatically update to the version copied on the USB drive.

Note: Installing will take 1-2 minutes.

4. After installation is complete, a message will appear to verify it was successful.

5. Safely remove USB drive once the update is complete.



Recommended USB drives include EMTEC, Kingston and Toshiba. Drives will need to be formatted as FAT32. If the Vortex8 fails to read the USB drive, please try one from a different manufacturer.

7. Camera Sync

7.1 Syncing to Cameras

The Vortex8 can be triggered from an external source, such as a sync generator (e.g. Ambient Lockit ACN-CL), or the genlock output of a cinema camera to ensure that it is synchronised with the camera shutter. This can be used to solve the frame tearing / flash banding problem most digital CMOS cameras can have with any flashing or strobing light source. It can also be used for frame-accurate strobing for advanced special effects, for frame rates up to 5,000fps.

Syncing to Camera with Sync/Genlock Input

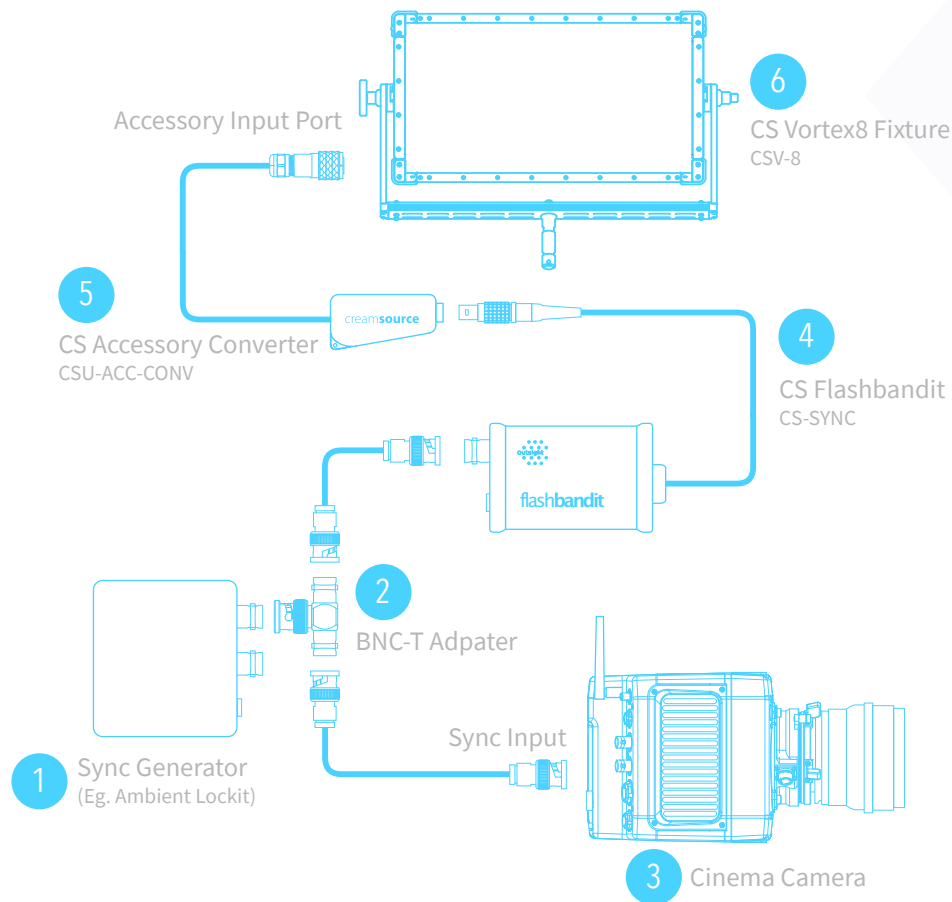

Syncing to Camera with Sync/Genlock Output

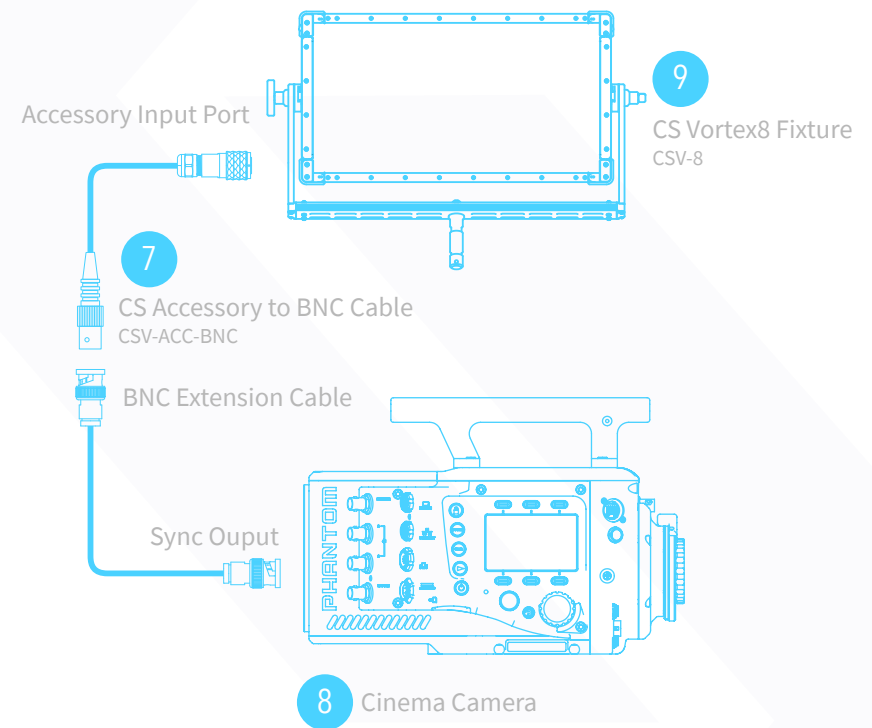

7. Camera Sync

7.2 Setting up Camera Syncing with Sync/Genlock Input using the Flashbandit

Use the Flashbandit (CS-SYNC) to setup cameras that requires a sync generator.

- 1 Set correct frame rate and format on the Lockit box 1 (see user manual for device). This should match the frame rate and format you intend to shoot at.
- 2 Plug the BNC-T adapter 2 into the SYNC/WORDCLOCK output of the Lockit box.
- 3 Connect the camera GENLOCK input 3 to the Lockit box 2 with the coaxial cable. Follow the camera instructions for setting this up.
- 4 Plug Flashbandit adapter 4 into the Creamsource Accessory adaptor. 5
- 5 Plug the Creamsource Accessory adaptor 5 into Accessories input of the Vortex8. 6
- 6 Connect the Flashbandit to the Lockit Box using coaxial cable – a blue light on Flashbandit should flash indicating valid signal.
- 7 Once sync is established, a green bar will be highlighted on the top of the status bar of the Vortex8 indicating the device is synchronised. The frame rate will also be displayed beneath the status bar.
- 8 Calibrate using the Flashbandit (see 7.5 Calibrate Sync for details).

7. Camera Sync

7.3 Setting up Camera Syncing with Sync/Genlock Output using the Accessory BNC Cable

Use the Creamsource Accessory BNC Cable (CSV-ACC-BNC) to setup cameras that are capable outputting a sync signal.

- 1 Plug the Creamsource Accessory to BNC Cable 7 directly into the BNC SYNC/AUX port of the camera. 8
- 2 Plug the other end of the Creamsource Accessory to BNC Cable 7 to the Accessory Input port of the Vortex8. 9
- 3 Setup the camera to output the sync signal (refer to the user manual for device).
- 4 Once sync is established, a green bar will be highlighted on the top of the status bar of the Vortex8 indicating the device is synchronised. The frame rate will also be displayed beneath the status bar.
- 5 Calibrate the Vortex8 (see 7.5 Calibrate Sync for details).

7. Camera Sync

7.4 Syncing Multiple Units

It is possible to distribute sync signal to multiple Vortex units using regular DMX cable. This allows for large arrays of Vortex to be precisely synchronised, without custom cables or extra hardware.

- 1 The sync source (camera genlock output, Flashbandit or other external trigger signal) should be connected to the Accessory port on the Master Vortex unit.
- 2 Connect DMX cable between the Master and the Secondary units using the DMX IN and DMX THRU ports.
- 3 Enable 'Send Sync via DMX' option on the Master unit (under Advanced > Sync Option menu)
- 4 Enable 'Receive Sync via DMX' option on the Secondary units (under Advanced > Sync Option menu)
- 5 You only need to calibrate sync on the Master unit, the Secondary units do not need to be calibrated. If using 'Invert Input Level' option, this only needs to be done on the Master unit.

NOTE: Regular DMX control cannot be used at the same time as sync over DMX. If you need remote control of the fixtures, you can still use CRMX Wireless, Bluetooth or sACN.

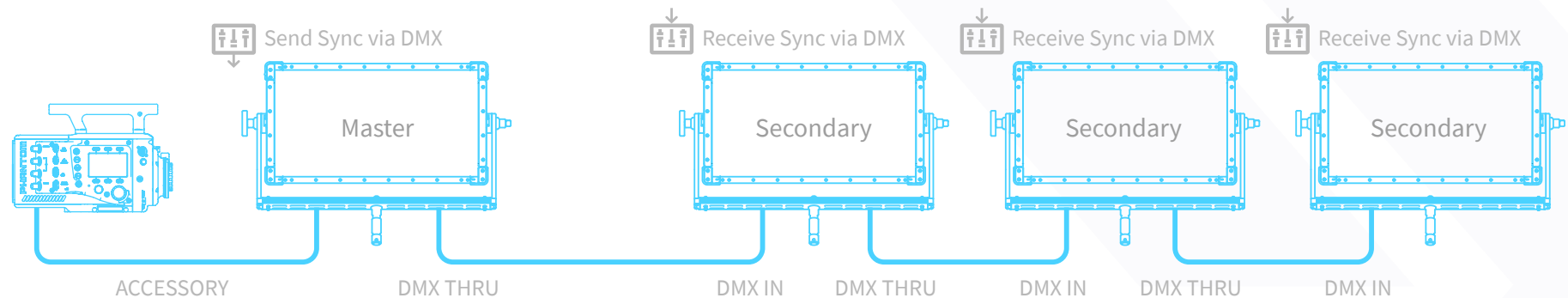

This status icon is shown if the DMX ports are being used for Camera Sync, and cannot be used for transmitting or receiving camera sync. This setting can be accessed under Advanced > Sync Options menu.

7. Camera Sync

7.5 Calibrate Sync

This is a special mode used for calibrating the light to an external sync source, such as the FlashBandit sync box. It is used to make sure the camera shutter and Creamsource are synchronised, to prevent the flash-banding effects when shooting on a CMOS sensor camera.

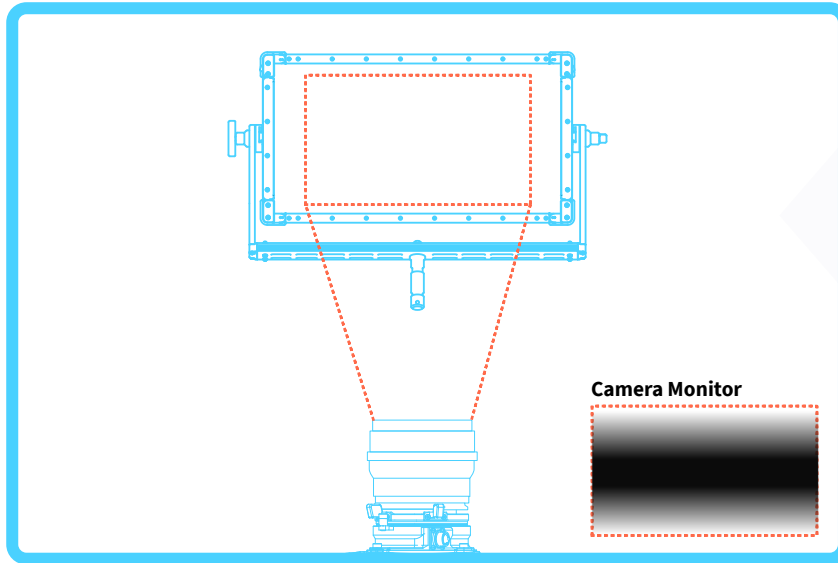

1 Point your camera directly at the Vortex8 so the entire frame is covered by the LEDs.



2 Select Effects > Calibrate Sync. The fixture will start to flash at the locked framerate (see 5.20 Calibrate Sync for more details on these settings).



If using multiple fixtures with sync distributed by DMX cable, only the first unit needs to be calibrated. If camera frame rate and/or shutter angle is changed, it is recommended to re-calibrate.

7. Camera Sync

7.5 Calibrate Sync Cont.

This is a special mode used for calibrating the light to an external sync source, such as the FlashBandit sync box. It is used to make sure the camera shutter and Creamsource are synchronised, to prevent the flash-banding effects when shooting on a CMOS sensor camera.

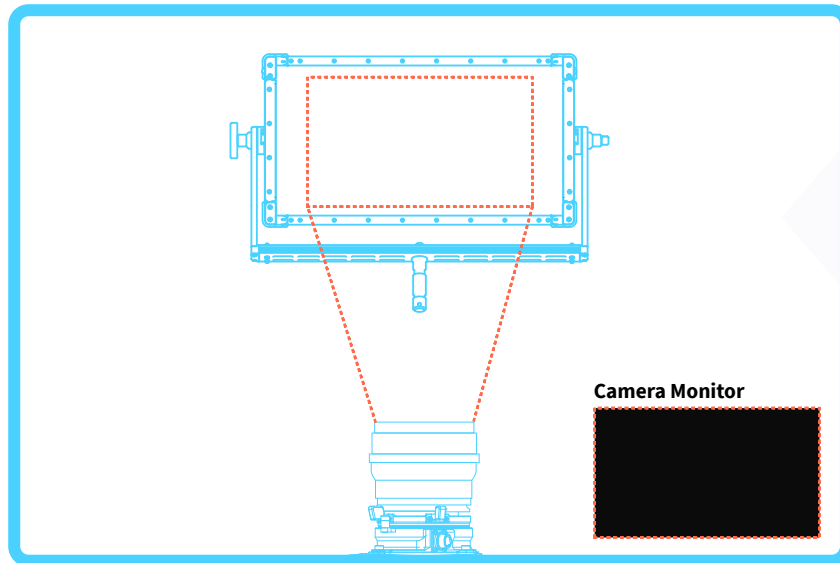

3 Adjust phase value on Calibrate Sync screen. As you change the phase, a dark band should appear to move up and down on the camera monitor. Adjust until the dark band fills the monitor completely. Shooting with wide shutter angles and at higher speeds reduces the size of the dark band, making calibration more difficult.



4 The Vortex8 is now calibrated. It can now be set to desired effect mode (Normal, Strobe etc) E.g. Select Effects > Flash Frames.

7. Camera Sync

7.6 Shooting While Calibrated

Once the Creamsource has been calibrated, any of the modes may be used without the possibility of causing torn frames. The remote dimmer unit or DMX control can also be used safely. If the framerate, shutter angle or the phase of the camera shutter is adjusted, then you will need to re-calibrate.

7.7 External Effects Triggering

You can use an external pulse to trigger the Sync Flash and Dual Level effects. This input is on the Accessory Connector, see Accessory pinout for more information.

- The Rising pulse edge triggers the effect, and is the same as pressing the FLASH button in.
- The Falling pulse edge is the same as releasing the FLASH button.
- The input level can be inverted by selected 'Invert Input Level' from the Advanced > Sync Options menu.

NOTE: An input voltage from 5V – 24V can be used for trigger signal. The input impedance is 150k Ω .

8. Maintenance

8.1 Vortex8 Fuse

The Vortex8 has an internal fuse and is not user serviceable. Please contact your nearest authorised repair centre for it to be replaced.

Require help finding your nearest authorised repair centre? Feel free to get in touch.

<https://creamsource.com/support>

Internal fuse is only for 48V DC, not AC input.



Acceptable Fuses:

*Bel Fuse Inc. **0ADKC9200-BE***

*Littelfuse Inc. **0215020.MXP***

9. Power

9.1 Running from Batteries

The Vortex8 can be run directly from a 48V regulated DC battery source with no additional hardware required. The fixture is also able to hot-swap between AC and DC power sources and is capable of running at 100% brightness while being powered by a battery. The battery must have sufficient capacity to continuously power the fixture with a current draw of 13.5A.

The Vortex requires an input voltage in the range of 45 - 50V DC. Most batteries will have a much larger range than this, so a regulated battery system is required to keep within the operating limits of the Vortex.

The DC input has over-voltage and under-voltage protection, and reverse polarity protection.



Some power will still be drawn from the battery if also running from AC power. Unplug battery when not in use to save energy.





Do not exceed 50v otherwise your Vortex8 may be damaged.

9. Power

9.2 Setting a Power Limit

Power draw of the fixture can be limited by setting a limit, in Watts. This can be set from 100W to 650W, in steps of 10W. The brightness level of the unit will be limited to keep within the power limit set. Note the limit only applies when a DC input is detected, and will apply even if AC source is also plugged in. Set the limit under MENU > Fixture Settings > Battery Power Limit.

- 
This icon indicates the unit is being powered via a battery source, and the power limit has been set but not yet reached.
- 
The icon will turn yellow if the power limit has been exceeded. The unit will dim to keep within the set power limit.

The table below shows power requirements when running at maximum brightness. Battery Amp-Hour ratings should be chosen accordingly.

Part Number	Wattage	Current Draw @ 48V
CSV-8 Vortex8	650W	13.5A

9. Power

9.3 Pinout for DC Power connector on Vortex8

Choose a 4 core cable of >17AWG (1.0mm²) and wire all 4 pins.

For a ready-made battery cable with 3 Pin XLR connector (Pin 1: -ve, Pin 2: +ve) see Creamsource Part number: CS-PWR-5M-XLR3.

Part Number	Connector	Manufacturer	Part Number
CSV-8 Vortex8	Ecomate 4 Pin Female	Amphenol	C016 20D003 110 10

Pin	Wire To
E	- Ve
1	- Ve
2	+ Ve
3	+ Ve

10. Specifications

10.1 Specs for the Accessory Port Pinout

Connector Type: Weipu Socket 7Pin

Mating Plug: Weipu Plug 7Pin SF1210/P7II

Pin	Description
1	Sync/Trigger Input +Ve (5-24V Input, referenced to GND)
2	DMX Data (-Ve)
3	DMX Data (+Ve)
4	
5	
6	GND, Ground Reference
7	+12V Output, 200mA maximum

10. Specifications

10.2 Specs for the Vortex8

Material	Aluminium/Technopolymer
Light Source	RGBW LED
Colour Range	CCT: 2200 - 15000K, PLUS/MINUS GREEN, HUE/SATURATION, XY, GELS, DIRECT RGBW, EFFECTS
CRI	Typical 95
TLCI	Typical 95
Beam Angle, SPOT Lens	20° (Half Peak Angle)
Tilt Angle	360°
Photometrics	<p>3200K:</p> <p>68,200 lx / 6,340 fc @ 1m / 3.3ft 26,200 lx / 2,430 fc @ 2m / 6.6ft 12,700 lx / 1,180 fc @ 3m / 9.8ft 7,400 lx / 690 fc @ 4m / 13.1ft 4,800 lx / 450 fc @ 5m / 19.4 ft 3,400 lx / 320 fc @ 6m / 19.7 ft</p> <p>5600K:</p> <p>73,500 lx / 6,830 fc @ 1m / 3.3ft 28,600 lx / 2,660 fc @ 2m / 6.6ft 13,900 lx / 1,290 fc @ 3m / 9.8ft 8,000 lx / 740 fc @ 4m / 13.1ft 5,200 lx / 480 fc @ 5m / 19.4 ft 3,700 lx / 340 fc @ 6m / 19.7 ft</p>
Mounting	8x 3/8" Threaded Insert Rigging Points
Yoke	Removable quick release yoke
Filter Rails	2 Filter Rails for Secondary Lenses, Diffusers, Accessories
User interface	High Precision Digital Magnetic Encoder, Backlit Keypad, Colour LCD Display
Dimming	0-100% with High Resolution, Super-Smooth Low End Mode

High Speed Capability	Over 5000fps Flicker Free in High Speed Mode
Synchronization	Sync Input for Triggering and Syncing to Camera Shutter
Max Ambient Temperature	40°C
Cooling	Low noise variable speed fans
Estimated LED Lifespan	50,000hrs (L70)
Input (AC)	100-240V AC, 50/60Hz, Max 6.6A. Neutrik PowerConTrue connector
Input (DC)	48V DC, Max 13.75A, Can run at 100% brightness on DC input
Protection Class	IP65
Weight	13.7kg / 30lb (Excluding Yoke) 1.98kg / 4.4lb (Yoke weight)
Dimensions	690 x 380 x 121mm / 27.2" x 15" x 4.8" (Excluding Yoke) 831 x 551 x 164mm / 32.7" x 21.7" x 6.4" (Including Yoke)
Warranty	3 Years on Fixtures, 12 Months on Accessories (5 Years registered)
Certifications	CE, RCM, FCC. Pending: ETC
Control	On-Board Interface, DMX via standard 5-pin XLR connectors, Wired Remote Control Accessory, Integrated Lumen radio Timo Two with Bluetooth, Ethernet, USB Type A
Includes	Vortex8 650W Colour, Yoke, Power cable, Flat diffuser
Product Code	K-CSV-8-ESS

10. Specifications

10.3 Warranty

We stand by our quality, to learn more about Warranty Terms and Conditions, please visit:

<https://creamsource.com/5-year-warranty>

10.4 Support

Have any questions? Feel free to get in touch

<https://creamsource.com/support>

Creamsource

2/49 Carrington Road Marrickville, NSW 2204 AUSTRALIA

10. Specifications

10.4 Document History

Revision	Date	Notes
1.0	14 Jan 2020	Initial Release
1.1	23 Apr 2021	Changes to the menu functions in 5. Controls.
1.2	17 Sep 2021	Updated the menu functions and features based on CreamOS 1.2.0.
1.2.1	27 Sep 2021	Added extra Tool Tips on the Connectivity section.



Creamsource

2/49 Carrington Road Marrickville, NSW 2204 AUSTRALIA